

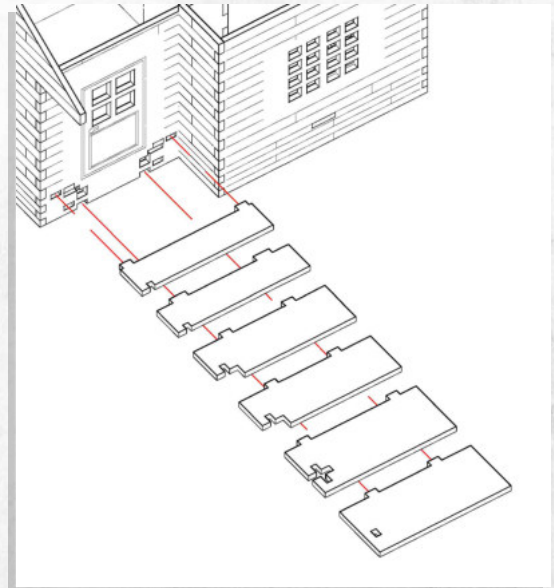

## Woodford - 2 Standing Rock - Assembly Guide

Parts may need careful removal from the MDF boards with a scalpel, and light sanding of any rough edges. We recommend testing assembling sections before permanently gluing together.

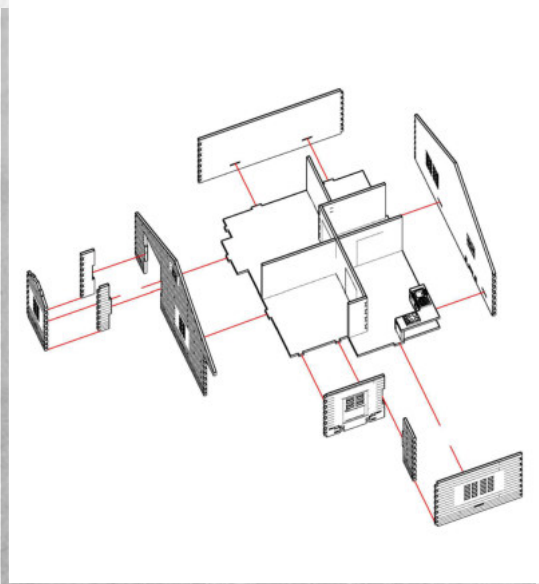

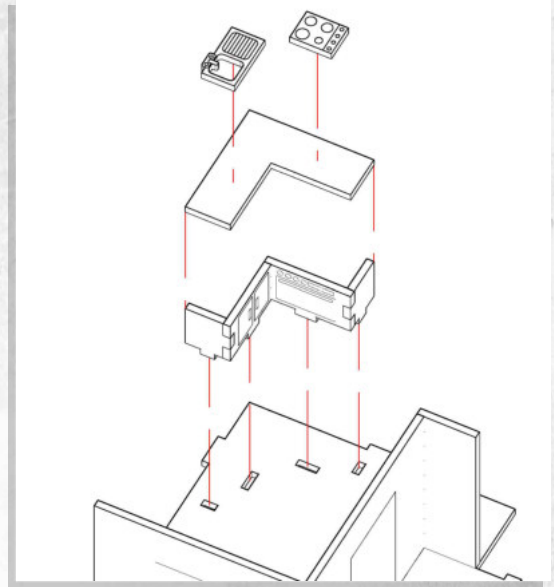
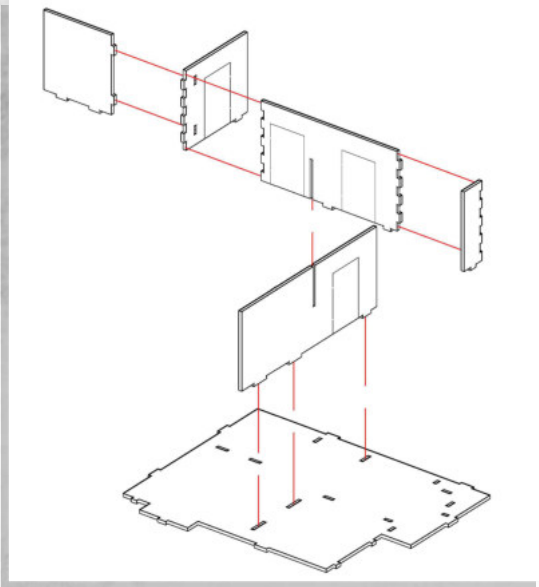

WARCRADLE<sup>TM</sup>  
SCENICS

## Woodford - 2 Standing Rock - Assembly Guide

Parts may need careful removal from the MDF boards with a scalpel, and light sanding of any rough edges. We recommend testing assembling sections before permanently gluing together.

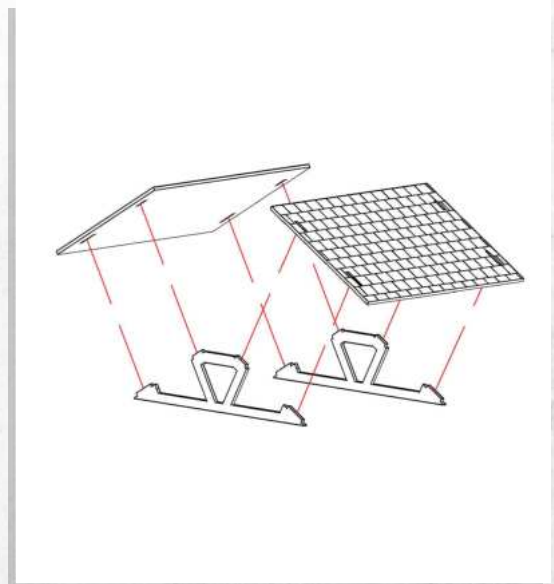
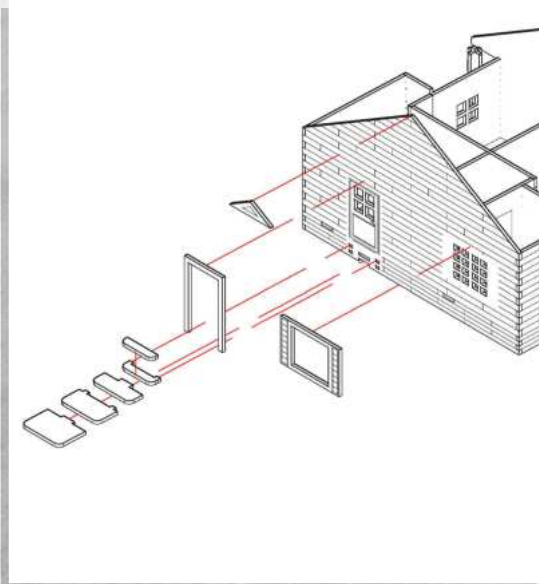
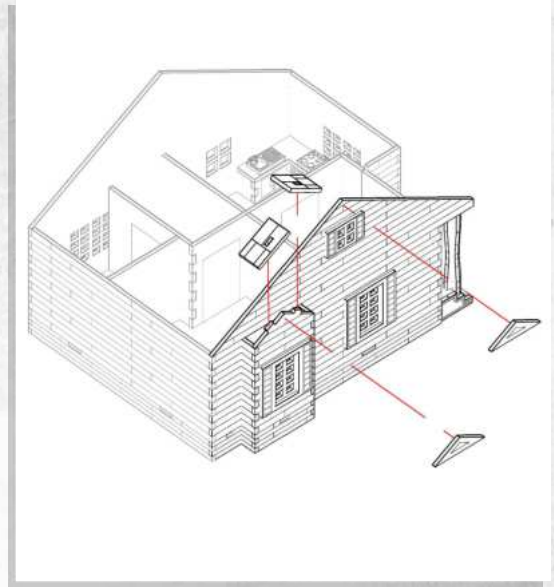
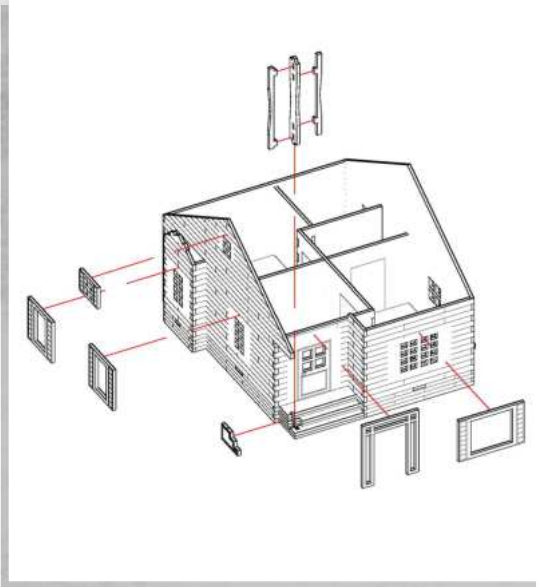

WARCRADLE<sup>TM</sup>  
STUDIOS

WARCRADLE STUDIOS IS A TRADING NAME OF WAYLAND GAMES LIMITED.  
ILLUSTRATIONS AND DESIGNS ARE COPYRIGHT © 2019 WAYLAND GAMES LIMITED. ASSEMBLED IN THE UK.



## Woodford - 2 Standing Rock - Assembly Guide

Parts may need careful removal from the MDF boards with a scalpel, and light sanding of any rough edges. We recommend testing assembling sections before permanently gluing together.

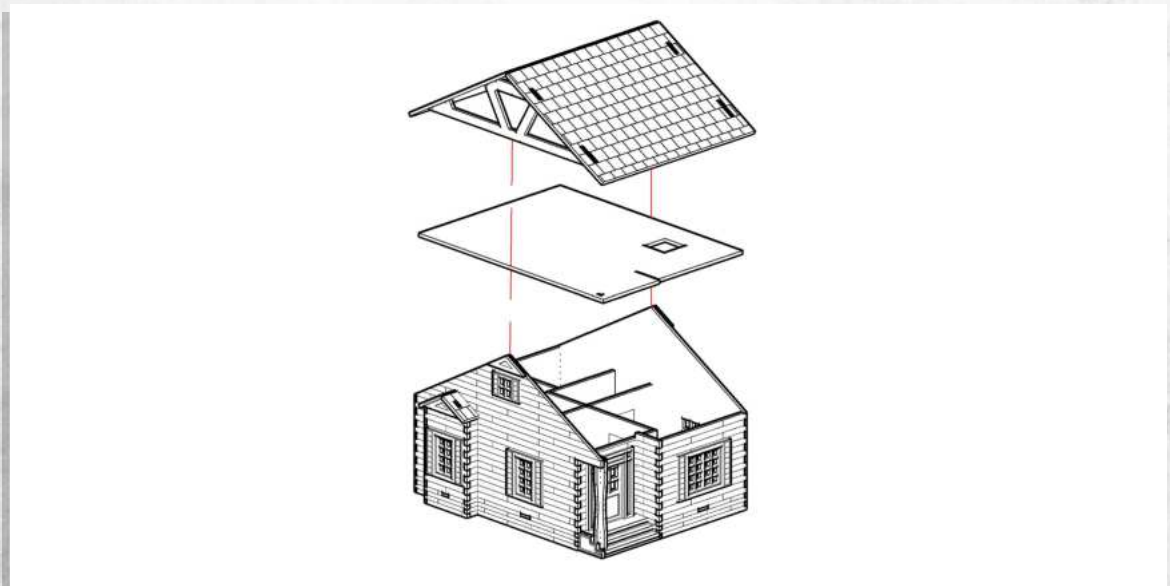
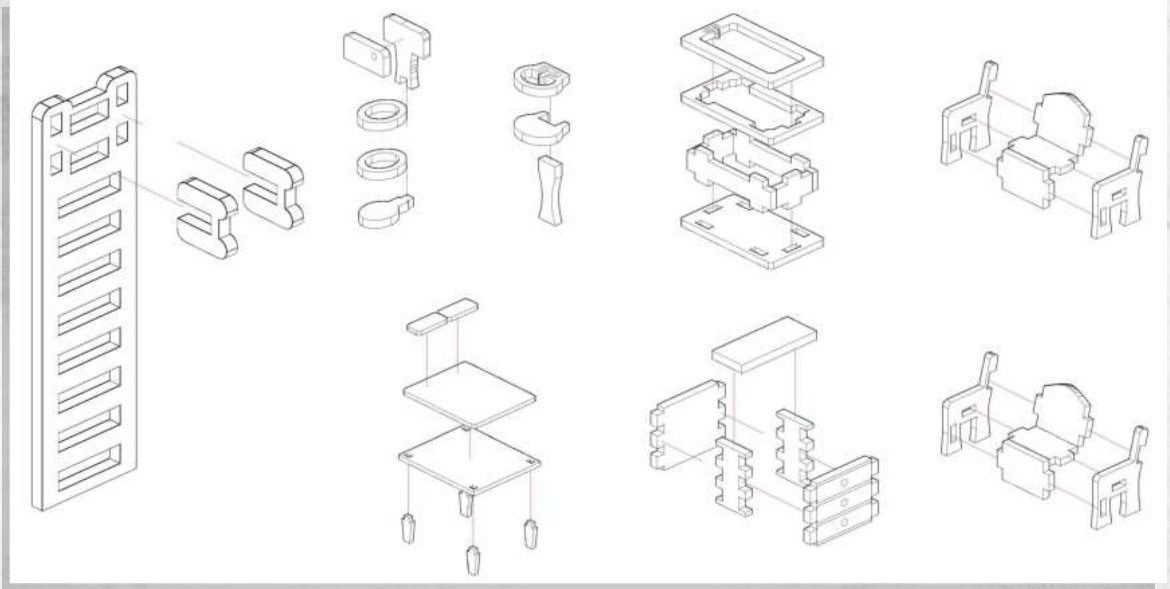

NOTE: Do not use glue for this step.