

## [PRODUCT - Tavern - Assembly Guide

Warning: Pushing parts out by hand may cause damage. Parts may need careful removal from the MDF boards with a scalpel, and light sanding of any rough edges. We recommend testing assembling sections before permanently gluing together.

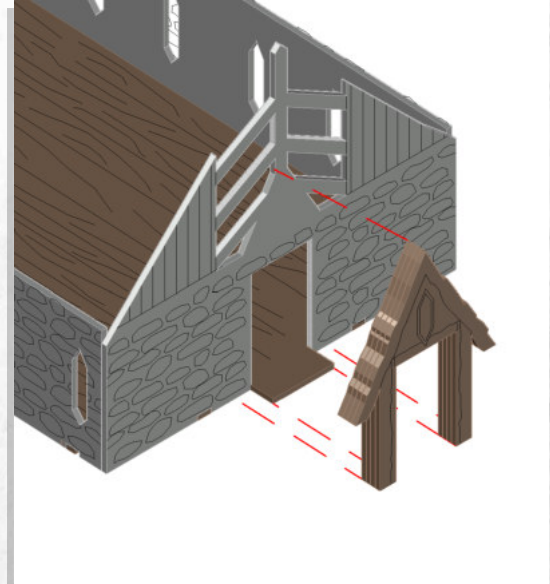
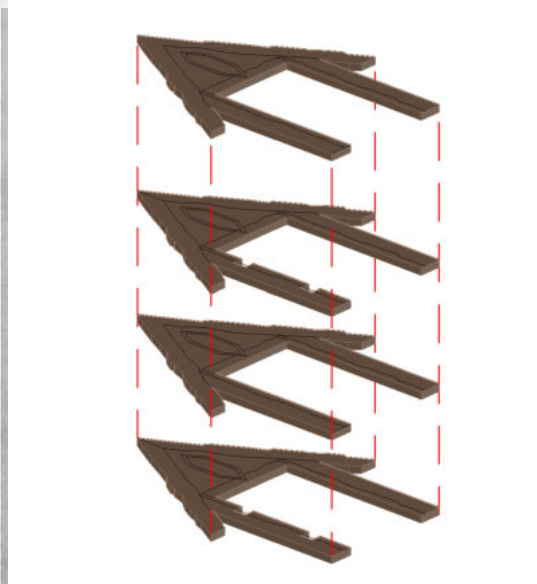
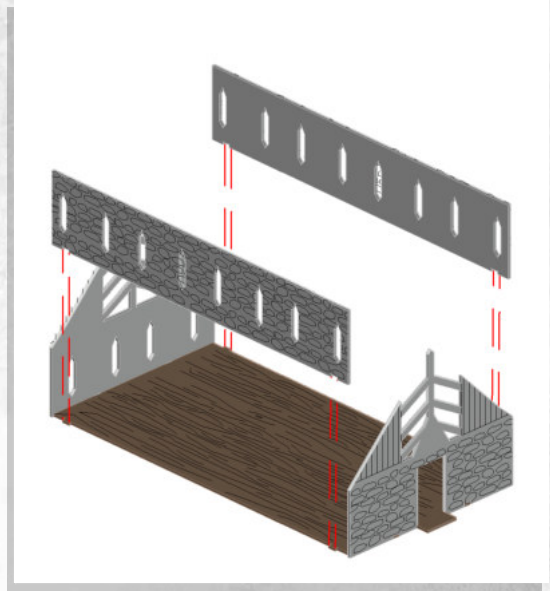
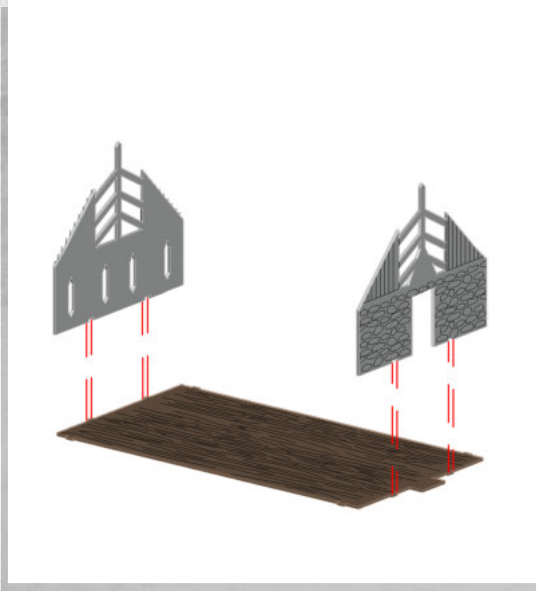

## Estun Village- Tavern- Assembly Guide

Warning: Pushing parts out by hand may cause damage. Parts may need careful removal from the MDF boards with a scalpel, and light sanding of any rough edges. We recommend testing assembling sections before permanently gluing together.



Do Not Stick

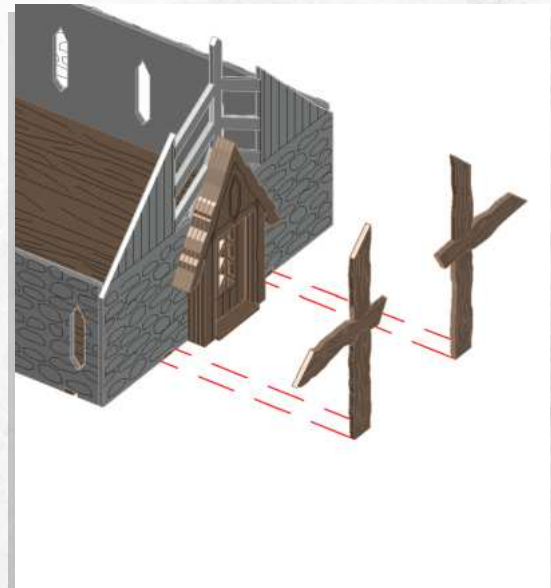



## Estun Village - Tavern - Assembly Guide

Warning: Pushing parts out by hand may cause damage. Parts may need careful removal from the MDF boards with a scalpel, and light sanding of any rough edges. We recommend testing assembling sections before permanently gluing together.

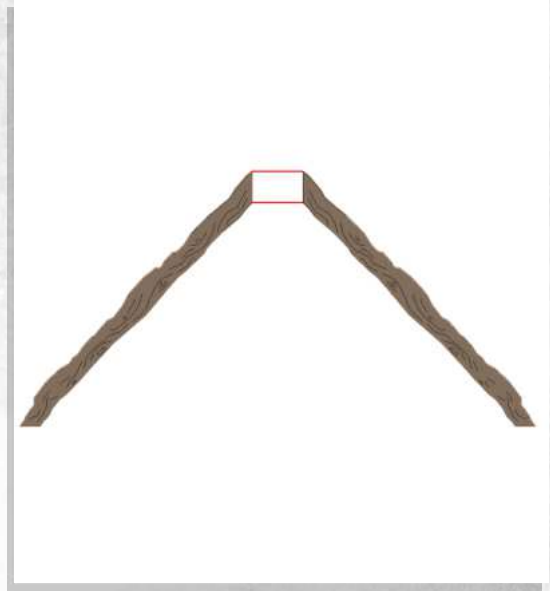
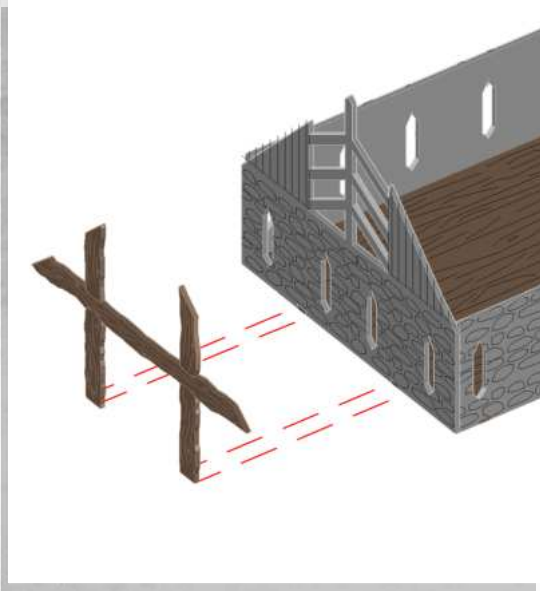

Do Twice



Do Twice

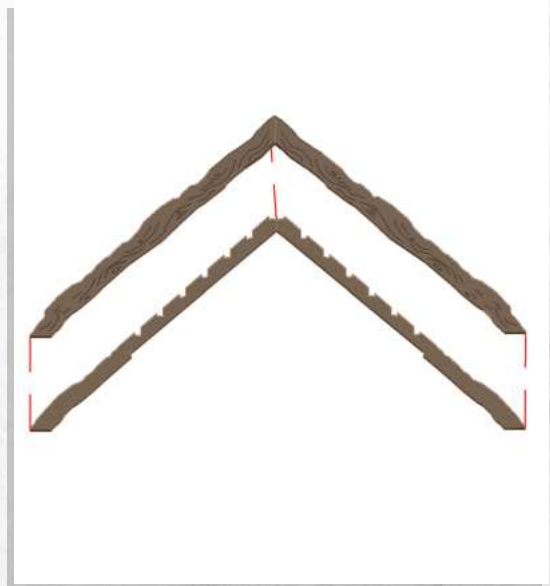

Do Twice

## Estun Village - Tavern - Assembly Guide

Warning: Pushing parts out by hand may cause damage. Parts may need careful removal from the MDF boards with a scalpel, and light sanding of any rough edges. We recommend testing assembling sections before permanently gluing together.

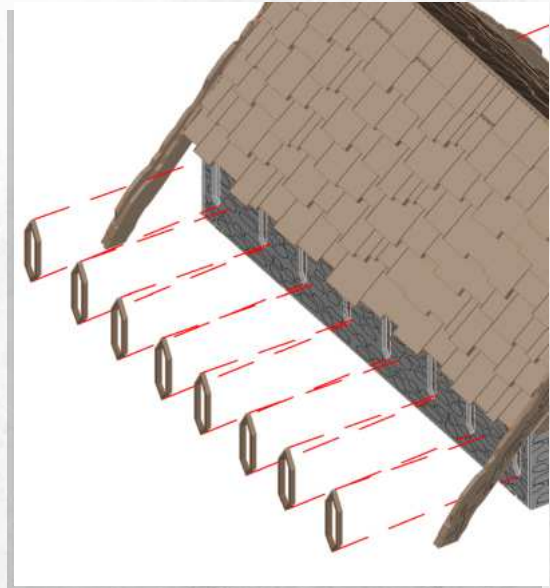
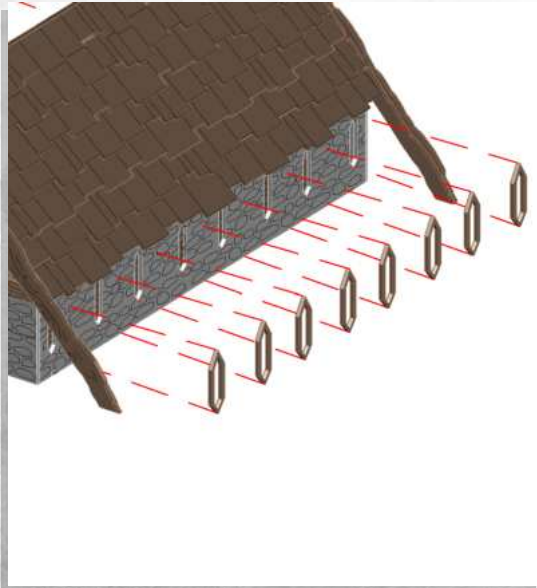
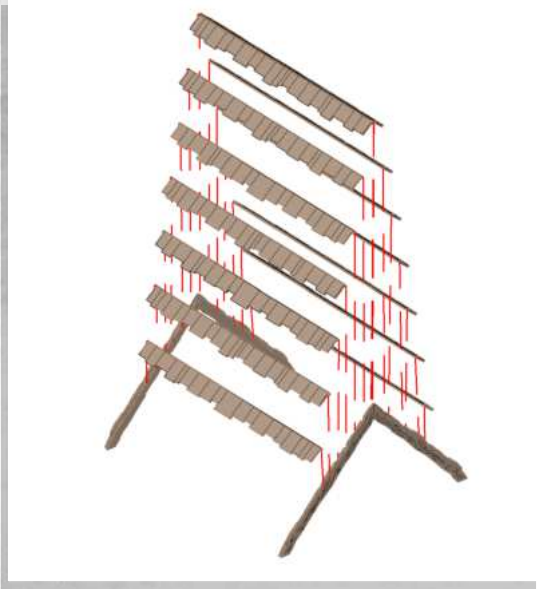

## Estun Village - Tavern - Assembly Guide

Warning: Pushing parts out by hand may cause damage. Parts may need careful removal from the MDF boards with a scalpel, and light sanding of any rough edges. We recommend testing assembling sections before permanently gluing together.

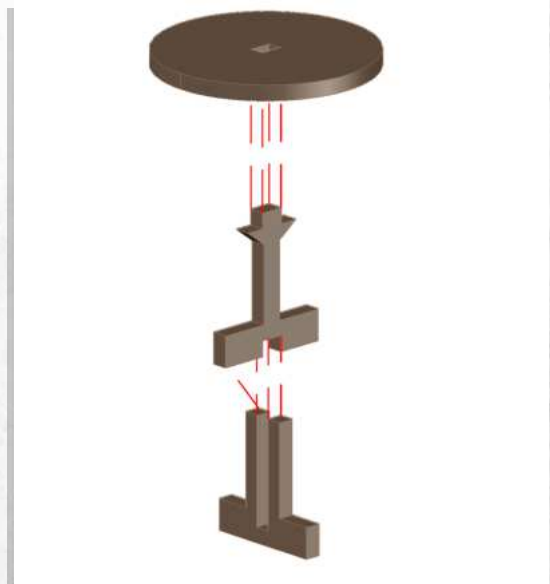
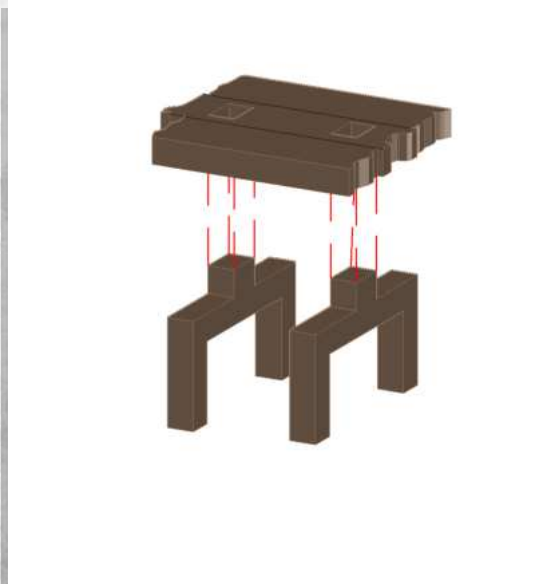
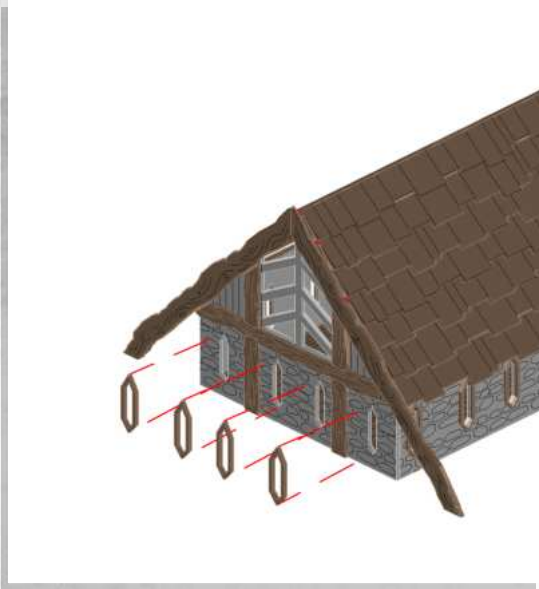



## Estun Village - Tavern - Assembly Guide

Warning: Pushing parts out by hand may cause damage. Parts may need careful removal from the MDF boards with a scalpel, and light sanding of any rough edges. We recommend testing assembling sections before permanently gluing together.

